

1. Features



- Operating voltage 120~277V AC, suitable to Euro & North American market.
- Patented microwave antenna, mounting height is 15m Max, suitable to install in most of warehouses.
- Supports high-sensitivity and low-sensitivity modes (for metal ceilings, metal reflector mounting environments)
- Work with 1-10V dimmable LED driver, easy to achieve 2-step or 3-step dimming function.
- New patented remote control to adjust the transmitting angle to avoid misuse.

2. Parameter

Input	Operating Voltage Range	108-305V AC, 50Hz/60Hz
	DC Input Voltage	N/A
	Rated Voltage	120/277Vac,60Hz
	No-load Power	N/A
	Stand-by Power	<1W
	Surge Test	L--N: 1kV
Output	Working Mode	ON/OFF function, 1-10V step dimming
	Type of Load	Inductive or resistive Load
	Load Capacity	120VAC: 4A; 277VAC: 3A
	Current of Load	N/A
	Max. Surge Capacity	50A (50% Ipeak, twidth =500uS, 230Vac full load, cold start); 80A (50% Ipeak, twidth =200uS, 230Vac, full load, cold start)
Dim Interface	1-10V Dimming	< 50mA (Non-constant source) 10%(1.4-1.6V), 20%(1.9-2.1V), 30%(2.9-3.1V), 50% (4.9-5.1V)
	Synchronous Control	N/A
	High Low-level	N/A
	PWM Control	N/A
Sensor Parameters	Operating Frequency	5.8 GHz ±75 MHz, ISM Band.
	Transmitting power	0.5mW Max.
	Hold time	5s/30s/1min/3min/5min/10min/20min/30min
	Stand-by DIM Level	10%/20%/30%/50%
	Stand-by Period	0s/10s/1min/3min/5min/10min/30min/+∞
	Detection Area	25%/50%/75%/100%

POTECH POWER TECHNOLOGY COMPANY LIMITED

Sensor Parameters	Daylight Sensor	5lux/15lux/30lux/50lux/100lux/150lux/Disable (Ambient light diffusion)
	Detecting Radius	See note 2
	Mounting Height	15m Max
	Detecting Angle	150°(wall mounting), 360°(ceiling mounting)
Wireless Module	Operating Frequency	N/A
	Transmitting power	N/A
	Transmitting distance	N/A
	Modulation mode	N/A
	Number of coding	N/A
Operating Environment	Operating Temperature	-35℃...+55℃
	Storage Temperature	Temperature:-40℃...+80℃;Humidity:10%-95% (non-condensing)
Certificate Standards	Safety standards	IEC60669-2-1, IEC60669-1 AS/NZS 60669.1, AS/NZS 60669.2.1 UL60730-1
	EMC standards	EN55015, EN61000-3-2, EN61000-3-3, EN61547 AS/NZS CISPR 15, AS/NZS 4268 FCC Part 15C, Part 15B EN 60950-1, EN301489-1, EN 201489-3, EN300440
	Environmental Requirement	Compliant to RoHS
	Certificate	cULus, CE, SAA, FCC, RED
Others	Wiring	SJTW,5*18AWG (USA); H05RR-F,5*18AWG (Europe,Australia); exposed line length: 810-830mm
	Wiring color	Sheath: Black Core: Red,White,Black,Gray,Purple (US); blue, brown, red, purple,Gray (Europe, Australia)
	IP Rating	IP65
	Protection Class	Class II
	Installation	Independent
	Dimension	(ΦxH)72*59mm
	Package	Instruction+ White box+ White box tags+ Clapboard+ Carton(K=A)
	Net Weight	MODEL A: 225g, MODEL B:246g, MODEL C:225g , MODEL D:165g
Lifetime	50,000h @ Ta Full load	
<p>Note</p> <p>1. "N/A"means not available.</p> <p>2. Detection area is effected on volume of motion object and motion speed. The detection area is tested by a 165cm height person and walking speed is 0.5m/s.</p>		

POTECH POWER TECHNOLOGY COMPANY LIMITED

3. Function

1) On/OFF Function (stand-by period be set to "0"s)

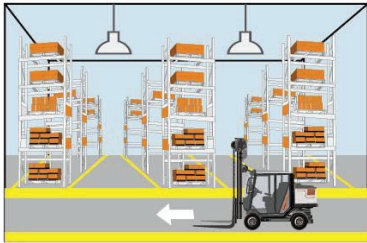

1 With sufficient ambient light, the light will not be switched on even if with motion signal.

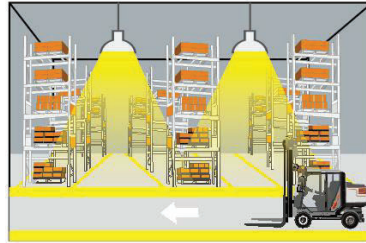

2 With insufficient ambient light, the sensor switches on the light when motion is detected.

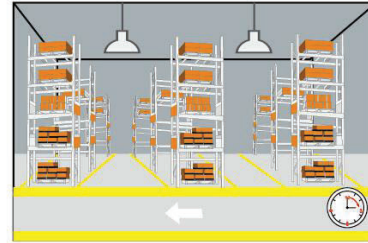

3 After elapse of hold time, the sensor switches off the light when no motion is detected.

2) 2-step dimming function (stand-by period be set to "+∞")

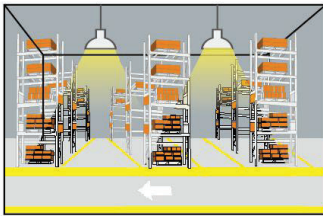

1 If there is no motion detected, the light will be remained at a low light level all the time.

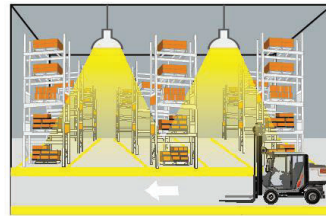

2 When motion is detected, the sensor will switch on the light to 100% brightness

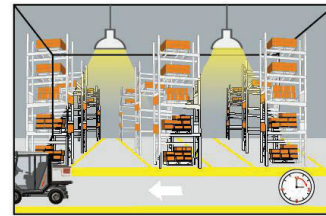

3 After elapse of hold time, the sensor dims the light at the present low light level if no motion is detected.

3) 3-step dimming function (stand-by period be set to "10s/1min/3min/5min/10min/30min")

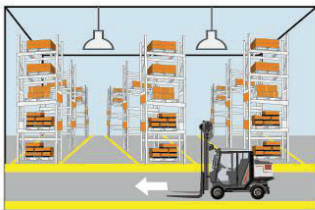

1 With sufficient ambient light, the light will not be switched on even if with motion signal.

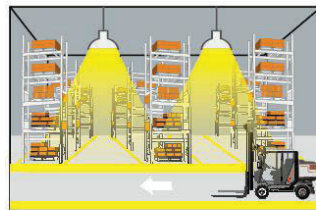

2 With insufficient ambient light, the sensor switches on the light when motion is detected.

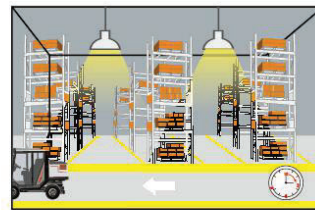

3 After elapse of hold time, the sensor dims the light at a low light level if no new motion is detected.

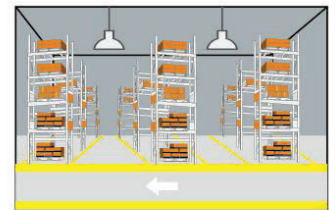

4 After elapse of standby period, the sensor switches off the light if no motion is detected in the detection zone.

4.Dimension (mm)

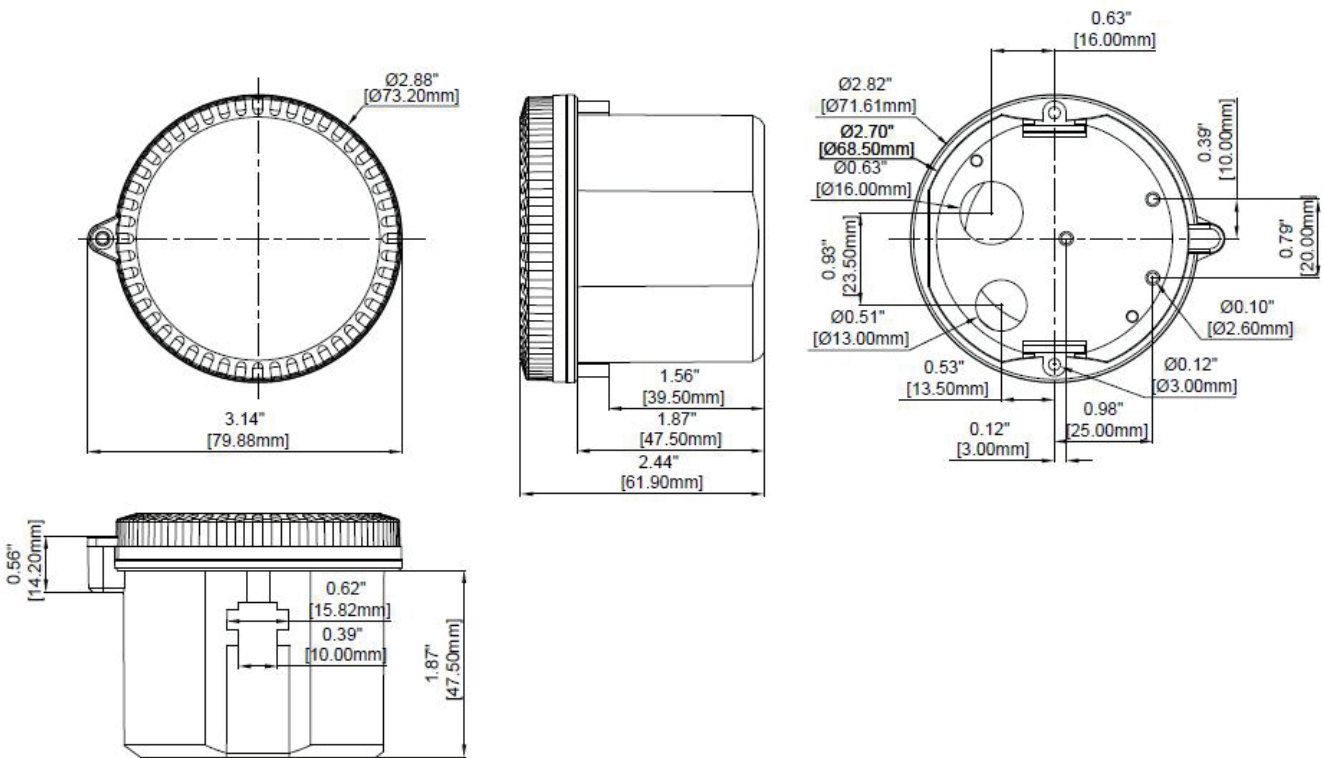

2) MODEL D

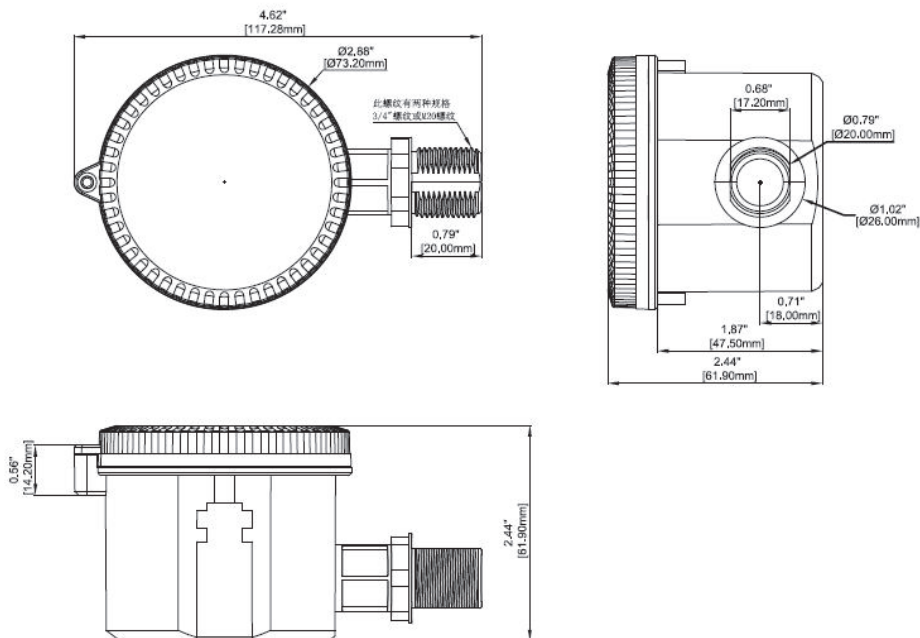

POTECH POWER TECHNOLOGY COMPANY LIMITED

5.Wiring

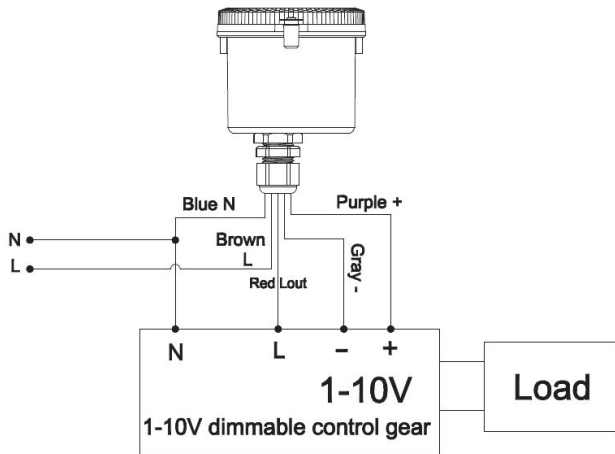

(Europe,Australia version)

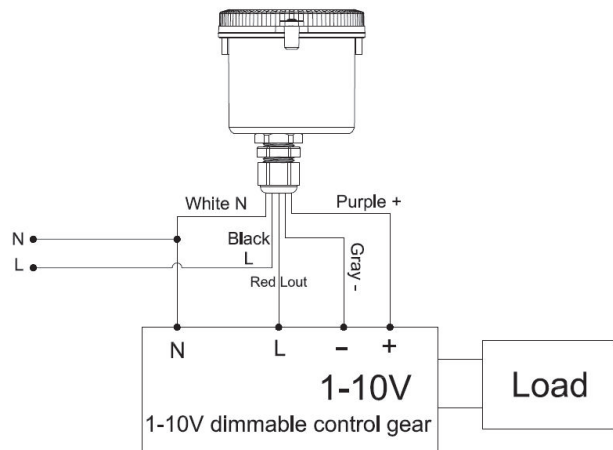

(USA version)

*The sensor is designed for connect one load only. Connect more than one loads may damage the sensor.

6.Function Diagram

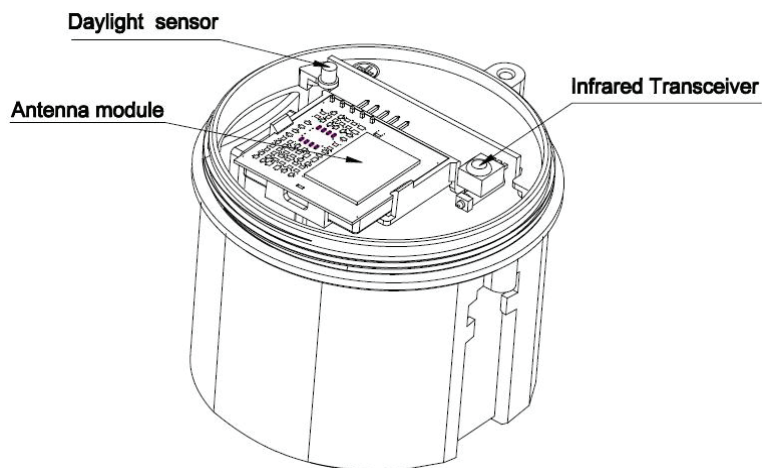

POTECH POWER TECHNOLOGY COMPANY LIMITED

7.Radiation Pattern

Ceiling mounting

Ceiling mounted
height: 3m
Sensitivity:
100%/75%/50%/25%

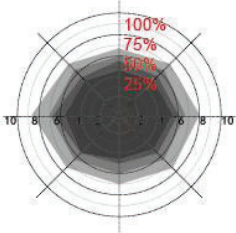

Normal moving
(Speed:1m/s)

Ceiling mounted
height: 6m
Sensitivity:
100%/75%/50%/25%

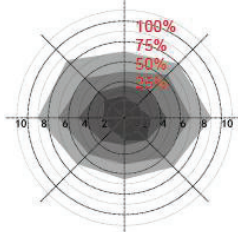

Normal moving
(Speed:1m/s)

Ceiling mounted
height: 9m
Sensitivity:
100%/75%/50%/25%

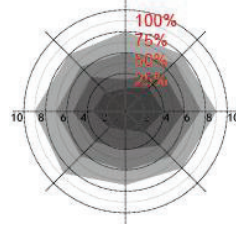

Normal moving
(Speed:1m/s)

Ceiling mounted
height: 12m
Sensitivity:
100%/75%/50%

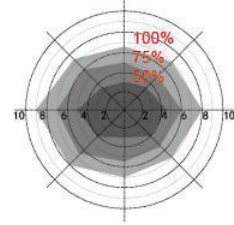

Normal moving
(Speed:1m/s)

Ceiling mounted
height: 15m
Sensitivity:
100%/75%

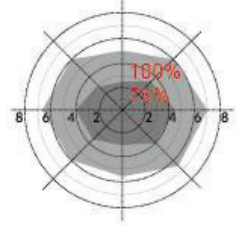

Normal moving
(Speed:1m/s)

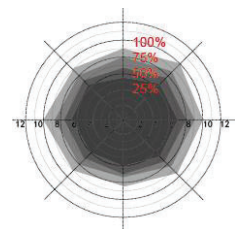

Slow moving
(Speed 0.3m/s)

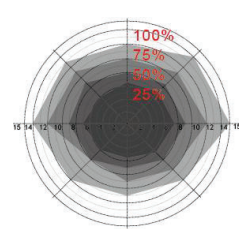

Slow moving
(Speed: 0.3m/s)

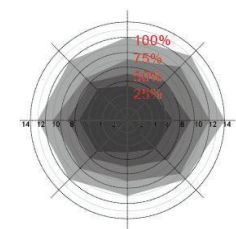

Slow moving
(Speed: 0.3m/s)

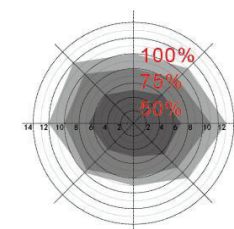

Slow moving
(Speed: 0.3m/s)

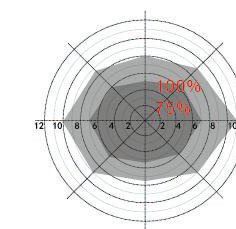

Slow moving
(Speed: 0.3m/s)

*Only 100%/75%/50% detection sensitivity is workable when installed at 10m & 15m mounting height. 25% sensitivity is not able to detect motion signal.

Wall mounting

Horizon mounted height: 2m
Sensitivity: 100%/75%/50%/25%

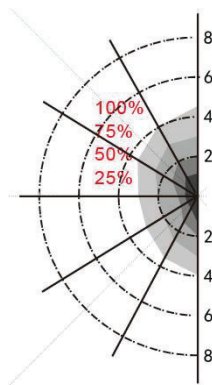

Normal moving (Speed: 1m/s)

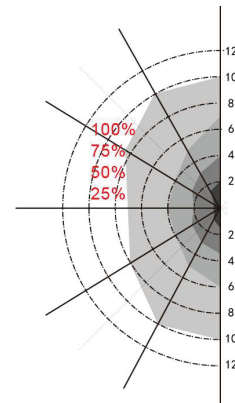

Slow moving (Speed 0.3m/s)

POTECH POWER TECHNOLOGY COMPANY LIMITED

8. Remote Control

Remote Control Setting	Button	Remarks																												
		Press the "ON/OFF" button, the light goes to constant on/off mode, sensor is disabled. Press "Reset" "Sensor motion" button to quit from this mode and the sensor starts to work.																												
		Press "Reset" button, all parameters are same as setting of factory settings.																												
		Press "Sensor motion" button, the light quits from the constant on/ off mode, and the sensor starts to work (The latest setting stays in validity)																												
		Press "DIM Test" button, the 1-10 V dimming works to test whether the 1-10Vdc dimming ports are connected properly. After 2s, it returns to the latest setting automatically.																												
		"Override DH", and "DH Mode" that the two functions are not applicable for MC054V RC2.																												
		<table border="1"> <thead> <tr> <th>Scene Options</th> <th>Detection Area</th> <th>Hold Time</th> <th>Stand-by period</th> <th>Stand-by dim level</th> <th>Daylight Sensor</th> <th>Sensitivity model</th> </tr> </thead> <tbody> <tr> <td>Q01</td> <td>100%</td> <td>5min</td> <td>10min</td> <td>10%</td> <td>30Lux</td> <td>Hs</td> </tr> <tr> <td>Q02</td> <td>100%</td> <td>10min</td> <td>30min</td> <td>10%</td> <td>Disable</td> <td>Hs</td> </tr> <tr> <td>Q03</td> <td>100%</td> <td>20min</td> <td>30min</td> <td>10%</td> <td>Disable</td> <td>Hs</td> </tr> </tbody> </table> <p>Note: Detection area / Hold time /Stand-by period /Stand-by dim level / Daylight sensor can be adjusted by pressing the corresponding button. The latest setting will stay valid.</p>	Scene Options	Detection Area	Hold Time	Stand-by period	Stand-by dim level	Daylight Sensor	Sensitivity model	Q01	100%	5min	10min	10%	30Lux	Hs	Q02	100%	10min	30min	10%	Disable	Hs	Q03	100%	20min	30min	10%	Disable	Hs
	Scene Options	Detection Area	Hold Time	Stand-by period	Stand-by dim level	Daylight Sensor	Sensitivity model																							
	Q01	100%	5min	10min	10%	30Lux	Hs																							
	Q02	100%	10min	30min	10%	Disable	Hs																							
	Q03	100%	20min	30min	10%	Disable	Hs																							
		Press the "TEST 2S" button can enter the test mode any time. At the mode, the sensor parameters as below: Detection Area is 100%, Hold Time is 5s, Stand-by Dim Level is 10%, Stand-by Period is 0s, daylight sensor disable. This function only for testing. Quit the mode by pressing "RESET" or any other function buttons.																												
		Press "HS" button to set the detection area to be high sensitive. Press "LS" button to set the detection area to be low sensitive. The adjustment bases on the "Detection Area" parameter you set.																												
		Daylight Sensor Set up daylight threshold: 5Lux/15Lux/30Lux/50Lux/100Lux/150Lux/ Disable.																												
		Stand-by period Set up stand-by time: 0S/10S/1min/3min/5min/10min/30min/+∞																												
		Hold time Set up hold time: 5S/30S/1min/3min/5min/10min/20min/30min																												
	Stand-by dim level Set up stand-by dim level: 10%/20%/30%/50%																													
	Detection Area Set up detection area: 25%/50%/75%/100%																													
	Remote Distance Toggle button can set the remote distance of remote control and sensor.																													

9. Initialization

1/ On/Off function /3-step dimming function:

After power on, the sensor automatically turns on light at 100% brightness. After 10sec, it turns off the light. During the initialization, the sensor is not able to detect movement.

2/ 2-step dimming function:

After power on, the sensor automatically turns on light at 100% brightness. After 10sec, it dims the light to a low light level (set by stand-by dim level). During the initialization, the sensor is not able to detect movement.

POTECH POWER TECHNOLOGY COMPANY LIMITED

10. Factory Setting

Detection area: 100%, Hold Time: 5S, Stand-by Period: 0s, Stand-by dim level: 10%, Daylight Sensor: Disable

11. Application Notice

- 1) The sensor should be installed by a professional electrician. Please turn off the power before installing, wiring, changing the setting of the DIP switch.
- 2) The sensor which installed in the plastic and glass lampshade will reduce the sensitivity. For every 3mm increase in thickness, the sensitivity will be reduced by 20%.
- 3) The dimming performance could be different from different 1-10v drivers.
- 4) The light sensitivity threshold is in a sunny environment, no shadow and ambient light diffuse reflection. Ambient lux level could be different in different environment, weather, climate, time-of-day and season.
- 5) The parameters of the sensor may need to be reconfigured in different installation environments. Please refer to the following instructions or contact the manufacturer.
- 6) This sensor is for indoor use only. It will affect the waterproof effect for outdoor use. Wind, rain, and moving objects around will cause false triggering.
- 7) The distance between any inductive sensors should be greater than 3m.
- 8) Do not place the sensor close to high-density objects such as metal, glass, concrete walls, etc, false triggering could happen. When the sensor is installed in a metal lamp, metal reflective surface, or a narrow enclosed environment, the microwave will be reflected repeatedly and cause false triggering. Please reduce the sensitivity or contact the manufacturer for technical support.
- 9) Please ensure that there are no moving signals around the sensor, such as fan, DC motor, sewer pipe, air outlet, etc., the sensor may generate false trigger.
- 10) You are advised to test 5 samples before mass application of sensor in a new lighting project.
- 11) Due to continuous improvement, the contents of this instruction could be changed without prior notice.

12. Version Change

Version	Date	Description
04	March 16, 2021	Released new product

POTECH POWER TECHNOLOGY COMPANY LIMITED